



Weekday / weekend room temperature controller REV17..

Heating applications

- Mains-independent, battery-operated room temperature controller featuring user-friendly operation, easy-to-read display and large numbers
- Self-learning two-position controller with PID response (patented)
- Operating mode selection:
 - 7-day (weekday / weekend) automatic mode.
with max. 3 heating phases
 - Continuous comfort mode
 - Continuous energy saving mode
 - Frost protection
 - Exception day (24 hour operation) with max. 3 heating phases
- A separate temperature setpoint can be entered in automatic mode and for the exception day for each heating phase
- To control a heating zone

Use

Room temperature control in:

- Single-family and vacation homes
- Apartments and offices
- Individual rooms and professional office facilities
- Commercially used spaces

Control for the following equipment:

- Magnetic valves of an instantaneous water heater
- Magnetic valves of an atmospheric gas burner
- Forced draught gas and oil burners
- Electrothermal actuators
- Circulating pumps in heating systems
- Electric direct heating
- Fans of electric storage heaters
- Zone valves (normally open or normally closed)

Function

- PID control with self-learning or selectable switching cycle time
- 2-point control
- 7-day time switch
- Remote control
- Preselected 24-hour operating modes
- Override function
- Holiday mode
- Party mode
- Frost protection mode
- Information level to check settings
- Reset function
- Sensor calibration
- Minimum limitation of setpoint
- Periodic pump run
Protection against valve seizure
- Synchronization to radio time signal from Frankfurt, Germany (REV17DC)

Type summary

Room temperature controller with 7-day (weekday/weekend) time switch	REV17
Room temperature controller with 7-day (weekday/weekend) time switch and receiver for time signal from Frankfurt, Germany (DCF77)	REV17DC

Ordering

Please indicate the type number as per the "Type summary" when ordering.

Delivery

The controller is supplied with batteries.

Mechanical design









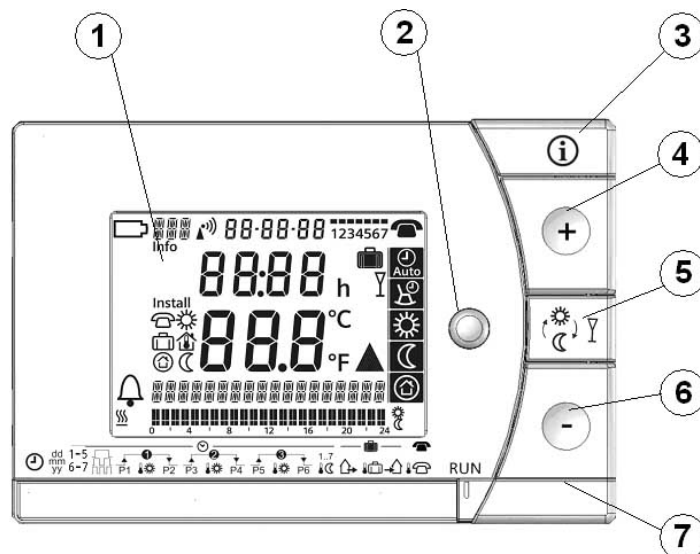









Plastic casing with an easy-to-read display and large numbers, easily accessible operating elements, and removable base.





The housing contains the controller's electronics, DIP switches, and the relay with potential-free changeover contact. The easily accessible battery compartment allows for easy exchange of two 1.5 V alkaline batteries, type AA.

The base with terminal block provides lots of space to connect the wires.

Display and operating elements







1		Display		
	Change battery	17-03-08	Date (day - month - year)	
	Alarm	22:30	Time of day	
	Heating mode	21.0°C	Room temperature (measured)	
		TEMPERATURE	Clear text display line (max. 18 spaces)	
	Weekday (max. 3 spaces)		24 hour timeframe	
Info	Info		Switching pattern with flashing time cursor	
Without language selection		Setpoint for remote control	 12345  67	
		Setpoint for comfort mode		
		Setpoint for absence	h	Time unit
		Room temperature		Absence/holiday mode set
		Setpoint for frost protection mode		Absence/holiday mode active
		Energy saving mode setpoint	Y	Party mode active
			°C / °F	Temperature unit °C or °F
		Time signal from Frankfurt		Heating/pump on
			Remote control active	











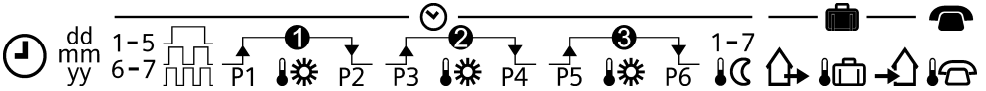





2		Operating mode selector	
	Automatic weekly mode with max. three heating phases per day.		
	Exception day with max. three heating phases.		
	Continuous comfort mode (= continuous comfort temperature).		
	Continuous energy saving mode (= continuous energy saving temperature).		
	Frost protection mode (= continuous frost protection temperature).		

3		INFO	
	Pressing the Info button once illuminates the display. Illumination automatically turns off after a short period of time. Pressing the Info button again activates the information display: Info is lit. The unit first displays queued error messages followed by important information (e.g. time switch programs, etc.).		

4		Plus button	
	Increase values, set time, or make a selection.		



5	Override button / party mode
	<p>In the time switch program, this button allows you to quickly change from the active temperature level to the next and back.</p> <p>Thus, you can quickly change to energy saving temperature when you leave the apartment for a short period of time, thus saving energy.</p> <p>The display indicates the change. It is valid only until the next switching time.</p> <p>Activate party mode: Press the button for 3 seconds.</p> <p>Party mode is available only in operating modes  and . In party mode, the controller controls to a freely selectable temperature for a freely selectable period of time.</p> <p>In party mode, symbol  is displayed along with the end of party mode.</p>

6	Minus button
	Decrease values, set time, or make a selection

7	Program selection slider
	
	Time
dd mm yy	Day – Month – Year (2 spaces for day, month, and year)
1-5 6-7	Block of weekdays or block of weekend
	1, 2, or 3 heating phases
 P1	Start Heating phase 1
 P3	Start Heating phase 2
 P5	Start Heating phase 3
 1	Setpoint Heating phase 1
 2	Setpoint Heating phase 2
 3	Setpoint Heating phase 3
 P2	End Heating phase 1
 P4	End Heating phase 2
 P6	End Heating phase 3
1-7 	Energy saving temperature in the automatic mode and exception day time switch programs
	Start of absence / holiday
	Temperature setpoint during absence / holiday
	End of absence / holiday
	Temperature setpoint at active remote control
RUN	Slider position RUN allows for closing the cover

Operating modes



Operation with time switch program

The controller offers the two time switch programs  and . Enter a start time and end time for each heating phase. Also comfort temperature setpoint can be freely entered for each heating phases. Between the heating phases the controller always switches to the same, freely selectable energy saving temperature setpoint.

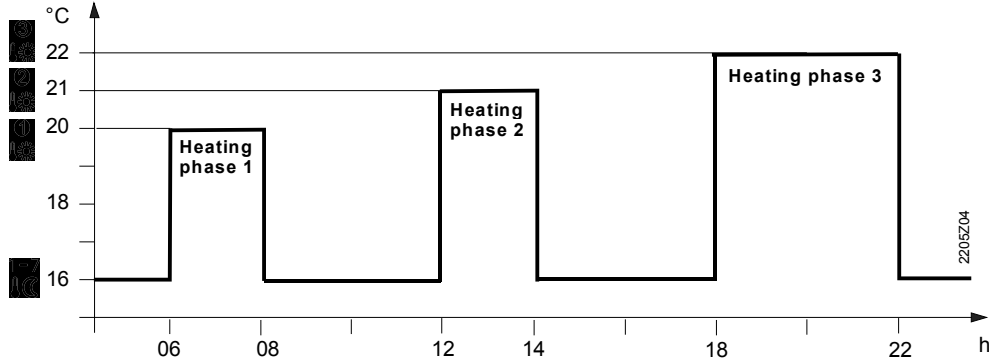
Example with 3 heating phases













Continuous operating modes



The controller also offers the three 3 continuous modes  comfort mode,  energy saving mode and  frost protection mode.

Setpoints

You can freely adjust the setpoints for the weekly and 24-hour operating modes. Setting range for all setpoints without setpoint limitation 3...35 °C. Setting range for all setpoints with setpoint limitation 16...35 °C.

Factory setting

Factory settings: Heating		
	①  ②  ③  	20 °C
	1-7  	16 °C
		8 °C
	  	12 °C

Factory settings: Switching times						
Heating phases	P1	P2	P3	P4	P5	P6
1. 	07:00	23:00	PASS	PASS	PASS	PASS
2. 	06:00	08:00	17:00	22:00	PASS	PASS
3. 	06:00	08:00	11:00	13:00	17:00	22:00

Weekday / Weekend - Time switch

Three different switching patterns are available to simplify entry of switching times. These can be assigned as blocks to the corresponding weekdays 1...5 and weekend days 6...7. As a result, you need to adapt the switching times and room temperatures only once for each block.

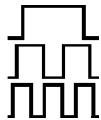
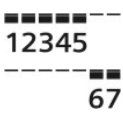













Switching pattern	Blocks
	 12345 67

Enter holidays or absences

You can enter the beginning, temperature and end of your holidays. At the beginning of the holidays, the controller switches to the desired holiday temperature and returns to the previously set operating mode at the end of the holidays.

In holiday mode, symbol  is displayed along with the end of holiday mode.

Proceed as follows to enter your settings:

	Set slider to position 15 (start of absence): Press  or  to set the start date for your holidays.
	Set slider to position 16 (temperature during absence): Press  or  to set the desired temperature while on holidays.
	Set slider to position 17 (end of absence): Press  or  to set the end date for your holidays.
RUN	Return the slider to position RUN. Symbol  is displayed to the left of the  symbol. Press  ,  ,  ,  or move the slider to end holiday mode prematurely.

Remote control

Use a suitable remote control unit to activate the "Remote control"  temperature setpoint in the controller. Changeover takes place by making a **potential-free contact** connected to terminals T1 and T2.

A flashing  symbol indicates active remote control mode.

After the contact opens, the previously set operating mode is reactivated.

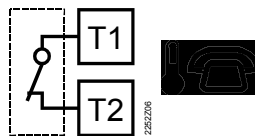
Operation according to controller setting	Temperature setpoint "remote control" active
	

Suitable remote control units are:



Telephone modem, manual switch, window contact, presence detector, central unit, etc.

Enter temperature for active remote control

You can freely select the temperature for active remote control. Activating remote control immediately enables control to the remote control temperature regardless of the currently active operating mode. When you deactivate remote control, the controller returns to the set operating mode.



A flashing  symbol indicates active remote control mode.

Proceed as follows to enter your settings:

	Set slider to position 18 (temperature for active remote control): Press  or  to set the desired temperature for active remote control.
RUN	Return the slider to position RUN .

Technical features

DIP switches



△ ON / ▽ OFF		1	2	3	4	5	6	7						
A	Sensor calibration On	△					△			Periodic pump run and anti-lime function On				
	Sensor calibration Off	▽					▽			Periodic pump run and anti-lime function Off				
B	Setpoint limitation 16...35 °C		△					△		Quartz				
	Setpoint limitation 3...35 °C		▽					▽		 Radio clock				
C	Temperature display °F			△			After you change one or several DIP switch positions, you must press the DIP switch reset button to reset the DIP switch. Otherwise, the previous setting remains active!			DIP switch reset 				
	Temperature display °C			▽										
D	PID self-learning				△	△								
	PID 6				△	▽								
	PID12				▽	△								
	2-point				▽	▽								
Factory setting: All DIP switches to ▽ OFF														

A Sensor calibration: DIP switch 1

If the displayed room temperature does not match the measured room temperature, the temperature sensor can be recalibrated.

Set DIP switch to ON and press the DIP switch reset button:

CAL symbol is displayed. The currently measured temperature flashes.

Press  or  to recalibrate by max. ± 5 °C.

Set DIP switch to OFF and press the DIP switch reset button to save the settings.

B Setpoint limitation: DIP switch 2

The minimum setpoint limitation of 16 °C prevents undesired heat transfer to neighboring spaces in buildings featuring several heating zones.

DIP switch ON: Setpoint limitation **16...35 °C**.

DIP switch OFF: Setpoint limitation **3...35 °C** (factory setting).

Press the DIP switch reset button to save the settings.

C Temperature display in °C or °F: DIP switch 3

DIP switch ON: Temperature display in **°F**.







DIP switch OFF: Temperature display in **°C** (factory setting).



Press the DIP switch reset button to save the settings.

- D Control behavior:**
DIP switches 4 and 5
- The REV17... is a two-position controller with PID control. The room temperature is controlled through cyclic switching of an actuating unit.
- DIP switches 4 ON and 5 ON: **PID self-learning**
Adaptive control for all applications.
- DIP switches 4 ON and 5 OFF: **PID 6**
Fast controlled system for applications in locations with large temperature deviations.
- DIP switches 4 OFF and 5 ON: **PID 12**
Normal controlled system for applications in locations with normal temperature deviations.
- DIP switches 4 OFF and 5 OFF: **2-point**
For complex controlled systems, simple two-position controller with 0.5 °C switching difference (factory setting).
Press the DIP switch reset button to save the settings.
- E Periodic pump run and anti-lime function:**
DIP switch 6
- Only applicable with controlled circulating pump or valve!
This function protects the pump or valve during extended OFF periods against possible seizure caused by liming. Periodic pump run is activated every 24 hours at 12 p.m. for three minutes (symbol ▲ is displayed during active pump run).
DIP switch ON: Pump run On.
DIP switch OFF: Pump run On (factory setting).
Press the DIP switch reset button to save the settings.
- F Radio clock:**
DIP switch 10
- Only applicable to REV..DC (with integrated DCF77 receiver to receive time signal from Frankfurt, Germany)!
DIP switch ON: Clock run by controller-internal quartz.
DIP switch OFF: ▲ Time signal DCF77 from Frankfurt, Germany.
Press the DIP switch reset button to save the settings.
- Note on synchronization**
- During startup, REV..DC synchronizes automatically to the time signal (DCF77) from Frankfurt, Germany. Synchronization takes max. 10 minutes. Synchronization restarts each time you press the button or move the program selection slider from the RUN position during these 10 minutes. Siemens recommends to set the desired settings upon startup, install the REV..DC in the desired location, and not carry out any actions on the REV..DC for the next 10 minutes.
- Note on reception**
- In normal operation, the REV..DC synchronizes to the radio clock every day at 3:10 a.m. The time signal from Frankfurt is modulated to a radio signal. The reception of this radio signal depends on the distance to Frankfurt, atmospheric conditions as well as the location where the REV..DC is installed. Siemens cannot guarantee that the REV..DC can receive the time signal from Frankfurt at any time and any place.
- No reception**
- The radio clock symbol is deactivated and an error message is displayed if the clock was not able to synchronize the time for 7 consecutive days. The controller then runs on the internal quartz.
- G DIP switch reset**
- After you change one or several DIP switch positions, you must press the DIP switch reset button to reset the DIP switch. Otherwise, the previous setting remains active!



Access to the expert level

Set the program selection slider to RUN. Press  and  simultaneously for 3 seconds, release the buttons, and within 3 seconds press and hold down  and  simultaneously for 3 seconds, release , and press  for another 3 seconds. This releases the engineering settings. **Install** is displayed.

The display first shows language selection with Code 00. Press the buttons  or  to navigate the settings.

Confirm settings by pressing .

Press the operating mode selector  to exit the engineering settings.

Code list



Function block	Code	Name	Factory setting	Your setting
Basic settings	00	Language	English	
	01	Sensor calibration	off	
	02	Switching differential 2-point	0.5 °C	
LCD optimization	10	Illumination time	10 seconds	
	11	Background brightness	0	
	12	Contrast	0	
Clock settings	30	Time zone Deviation from time signal in Frankfurt (Central European Time CET) (see Note 1)	0 hours	
	31	Start of daylight saving time (see Note 2)	31. March 31 (03-31)	
	32	End of daylight saving time (see Note 3)	31. October 31 (10-31)	

Note 1: This entry has no effect if the radio clock either is inactive or not available. The time signal received from Frankfurt is shifted by the value set in Code 30 (time zone) if the radio clock is active.

Note 2: The time is always changed over at 2 a.m. on the Sunday preceding the set date if there is no radio clock or if it is inactive. The time change is shifted by the value set in Code 30 (time zone) when the radio clock is active.

Note 3: The time is always changed over at 3 a.m. on the Sunday preceding the set date if there is no radio clock or if it is inactive.

Functional check

- Check the display. If there is no display, check insertion and function of the batteries.
- Operating mode "Continuous comfort mode" , read displayed temperature.
- Set the temperature setpoint higher than the displayed room temperature (see operating instructions).
- The relay and, as a result, the actuating device must switch at the latest after one minute. Symbol  is displayed. If not displayed:
 - Check actuating device and wiring.
 - It is possible that in heating mode the room temperature is higher than the set temperature setpoint.
- Set the temperature setpoint for operating mode "Continuous comfort mode"  to the desired value.
- Select the desired operating mode.

User-defined settings:



,  and  simultaneously for 3 seconds:

This resets all temperature and time settings of the program selection slider to default values (see also "Factory settings" in the operating instructions). The expert settings remain unchanged.

The clock starts at 12 p.m., the date on 01-01-08 (01 - January - 2008).

During the reset, all display fields are lit and can be checked accordingly.

All user-defined settings plus expert settings:

Press the DIP switch reset button ,  and  simultaneously for 5 seconds:

After the reset, **all factor settings** are reloaded. This applies to the program selection slider as well as to the expert settings.

Engineering

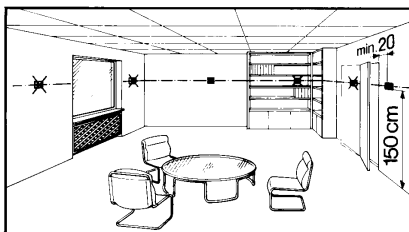

- Mount the room temperature controller in the main living room.
- Select the mounting place so that the sensor can acquire the air temperature in the room as accurately as possible and without being influenced by solar radiation or other heat or refrigeration sources.
- Mounting height is approx. 1.5 m above the floor.
- You can mount the unit on most commercially available recessed conduit boxes or directly on the wall.



Mounting and installation

- Begin installation by first attaching and wiring the base. You can mount the base on most commercially available recessed conduit boxes or directly on the wall. Then insert the controller from top to bottom into the base.
For more information, see the installation instructions supplied with the unit.
- Comply with all local regulations on electrical installation.
- Wire separately the remote control contact T1 / T2 using a separate, shielded cable.

Commissioning

- Remove from the batteries the battery transit tab designed to prevent premature activation of the unit: Select desired language by  or . Confirm by .
- You can change the control characteristics using the DIP switch on the rear of the unit.
- Set any thermostatic radiator valves to their fully open position, if present in the reference room.
- Recalibrate the temperature sensor (see "Sensor calibration") if the displayed room temperature does not match the room temperature measured.

Notes

This is a software class A controller designed for use at a normal degree of pollution.

Technical data

General unit data	Supply	DC 3 V
	Batteries (alkaline AA)	2 x 1,5 V
	Life	Ca. 2 years
	Backup of clock when changing battery (all other data remain in EEPROM)	Max. 1 min
	Switching capacity of relay	
	Voltage	AC 24...250 V
	Current	0.1...6 (2.5) A
	Protection class	II as per EN 60 730-1
	Sensing element	NTC 10 k Ω \pm 1 % at 25 °C
	Measuring range	0...50 °C
	Time constant	Max. 10 min
	Setpoint setting ranges	
	All temperature settings	3...35 °C
	Resolution for settings and displays	
Setpoints	0.2 °C	
Switching times	10 min	
Actual value measurement	0.1 °C	
Actual value display	0.2 °C	
Time display	1 min	
Standards	CE conformity	
	Electromagnetic compatibility	2004/108/EEC
	Low voltage directive	2006/95/EC
C-tick	 N474	
Product safety	Automatic electrical controls for household and similar use	
		EN 60 730-1
	Electromagnetic compatibility	
Environmental conditions	Immunity	EN 61000-6-2
	Emissions	EN 61000-6-3
	Operation	
	Climatic conditions	3K3 as per IEC 60 721-3
	Temperature	5...40 °C
	Humidity	<85 % r.h.
	Storage and transport	
	Climatic conditions	2K3 as per IEC 60 721-3
	Temperature	-25...70 °C
	Humidity	<93 % r.h.
Mechanical conditions	2M2 as per IEC 60 721-3	
Weight	Excl. packaging	0.29 kg
Color	Housing	RAL9003 signal white
	Base	RAL7038 gray
Size	Housing with base	90 x 134.5 x 30 mm

Connection diagrams

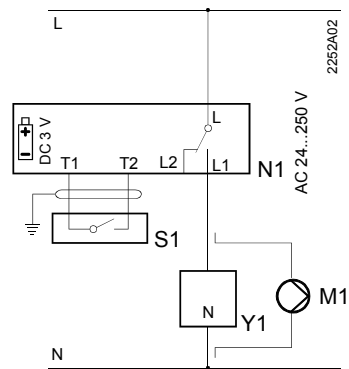

REV17 / REV17DC

L Phase, AC 24 ... 250 V
 L1 N.O. contact,
 AC 24 ... 250 V / 6 (2.5) A
 L2 N.C. contact,
 AC 24 ... 250 V / 6 (2.5) A
 M1 Circulating pump
 N1 REV17... controller

S1 Remote control unit (potential-free)
 T1 Remote control signal
 T2 Remote control signal
 Y1 Actuating device

Application examples

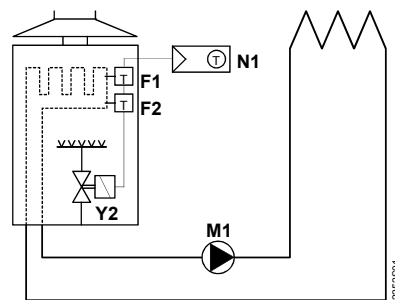

Instantaneous water heater

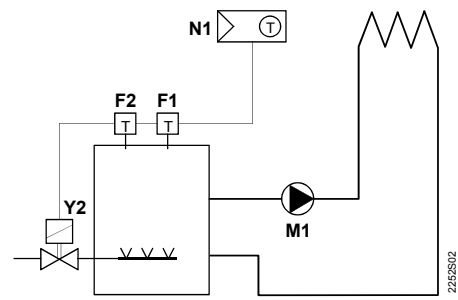

Atmospheric gas burner

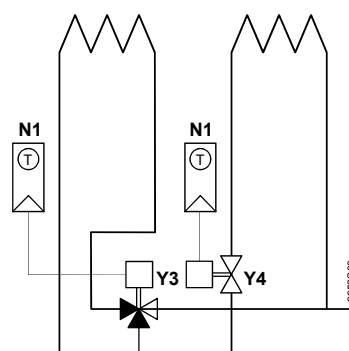

Zone valve

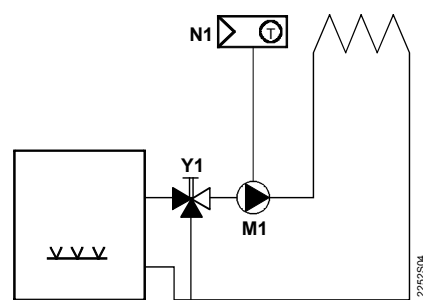

Circulating pump with precontrol by manual mixing valve

F1 Thermal reset limit thermostat
 F2 Manual reset safety limit thermostat
 M1 Circulating pump
 N1 REV17.. room temperature controller
 Y1 3-port valve with manual adjustment
 Y2 Magnetic valve
 Y3 Three-port valve with actuator
 Y4 Two-port valve with actuator

Dimensions

